

naxa

22" WIDE SCREEN HD LED TV WITH DVD PLAYER

MODEL NO: NTD-2252

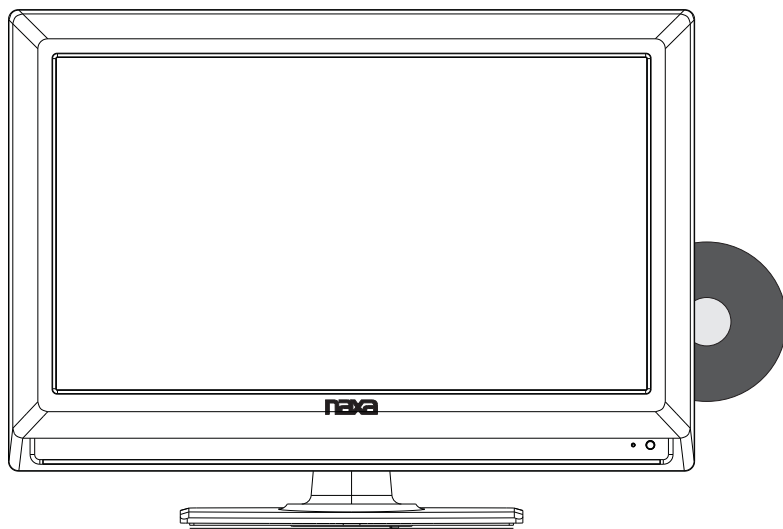

Instruction Manual

PLEASE READ CAREFULLY BEFORE USE

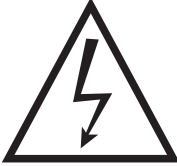

Table of Contents

SAFETY INFORMATION	1
WARNING	
IMPORTANT SAFETY PRECAUTIONS	
FRONT/BACK PANEL DIAGRAM	4
ACCESSORIES	5
REMOTE CONTROLLER	6
GENERAL DESCRIPTION	7-8
SYSTEMS CONNECTION	9-11
AV INPUT	
PC INPUT	
HDMI INPUT	
Y PB PR INPUT	
USB INPUT	
PICTURE	11
SOUND	14
CHANNEL MENU	15
PARENTALMENU	16
SETUP	19
OTHERS MENU	21
RESOLUTION	22
MTS (OPTIONAL)	22
DVD OPERATION	23-25
USB/SD OPERATION	26
HELP	27
SPECIFICATIONS	28

Safety Information

Warning

To prevent fire or shock hazard. Do not use this plug with an extension cord. Receptacle or other outlet unless the blades can be fully inserted to prevent the blade exposure. Do not expose this appliance near to rain or moisture.

 <p>The lightning flash with arrowhead symbol within an equilateral triangle, is intended to alert the user to the presence of uninsulated dangerous voltage within the products enclosure that may be of sufficient magnitude to constitute a risk of electric shock to persons.</p>	<p style="text-align: center;">WARNING</p> <p style="text-align: center;">RISK OF ELECTRIC SHOCK</p> <p style="text-align: center;">DO NOT OPEN</p> <p>WARNING: TO REDUCE THE RISK OF ELECTRIC SHOCK, DO NOT REMOVE COVER (OR BACK) NO USER-SERVICEABLE PARTS INSIDE, REFER SERVICING TO QUALIFIED SERVICE PERSONNEL</p>	 <p>The exclamation point within equilateral triangle is intended to alert the user to the presence of important operating and maintenance (servicing) instructions in the literature accompanying the appliance.</p>
--	---	--

Important Safety Precautions

Read these instructions.

Keep these instructions.

Heed all warnings.

Follow all instructions.

Please unplug the TV power cord when the following conditions occur:

--When there is a thunder storm (Please pull out the power cord and antenna)

--When Cleaning the TV set

--When the TV set not used for a long time.

Do not use corrosive deparative when cleaning the TV set.

Do not put the TV set under direct sunlight or near to the heat.

Do not put the naked light, for example, the lighting candle or the heater, on the top of or near to the TV set.

Leave plenty of space (at least 10cm) around the TV set for ventilation

Put the TV set away from where it can be ruined by the rain or water, (for example, near the window.)

Do not put the container with liquid (like a vase) on the top of the TV set.

Don't move away the TV set when turning on the power.

Don't touch, push and scratch the surface of TV set with hard stuff.

When the TV surface is dirty, please use the wet cotton cloth or soft cloth with non-corrosive cleanser to clean it carefully. Don't use the acetone, toluene or alcohol to clean the TV sets.

Be careful of the hydrosphere coagulation due to the temperature changing. The coagulated hydrosphere will damage inner electronic components. When the coagulated hydrosphere disappears, the TV screen may appear blur or spot.

Be sure to ask technicians to install the TV sets on the wall. The incorrect installations will put the TV sets into the unsafe situation.

Don't let the children climb up the TV sets or play near it in order to avoid being spilled from the TV sets or the TV sets damaged the children when falling down.

Don't hit the TV panel with hard objects (such as high-speed football or other objects) to prevent the panel from damages.

Don't cover the TV sets with quilts or other objects when it is working. Keep the heats dissipate and keep away from the fire.

Important Safety Precautions

Safety

Please immediately pull out the AC power plug from adapter if there is an abnormal sound or smell or the LED TV has sound but no picture, and contact after sales support.

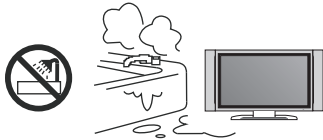

The LED TV should be kept free from rain, damp and dust to prevent electrical shock and short circuits. Do not cover the ventilation openings with table clothes, curtains, newspapers etc.

The LED TV should be kept from high temperature heating objects or direct sunlight. It requires good ventilation. Allow 10cm between the LED TV and other appliances or built-in cabinet walls.

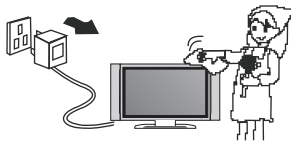
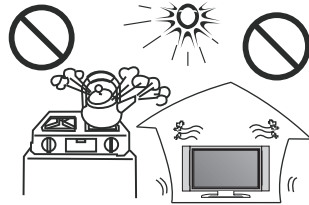

When you wipe the front cabinet, please make sure the power plug is pulled out and use a soft, dry, lint-free cloth and handle it with care. Do not repeatedly wipe the panel, nor scrape, tap or strike the panel with a hard object.

Do not wipe the LED TV with any petrol, chemical or alcohol based solvents as it will lead to product damage of the panel and cabinet.

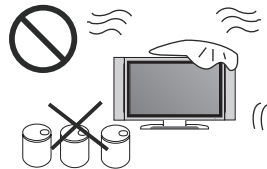

Important Safety Precautions

Safety

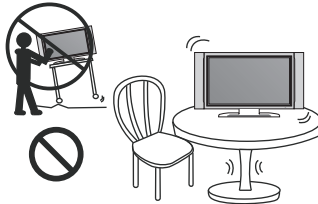

Do not place the LED TV on an unstable surface.

Do not place the power cord or other cables across a walkway in case it is trampled on. Do not overload the power cord or power socket. When the power plug is used to disconnection and connection device, it should be easy to operate

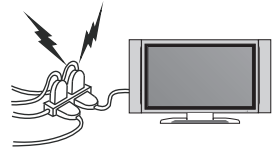

Do not disassemble the back cover as it contains high voltages inside and will cause electric shock. Internal adjustments and checks should only be conducted by qualified professionals.

The TV set should not be subjected to water droplets or water splash, equipment should not be placed on by objects filled with liquids

Do not place naked flame sources, such as lit candles on or near the LED TV. Please pull out the power plug and contact after sales support if there are abnormal objects or water in the TV.

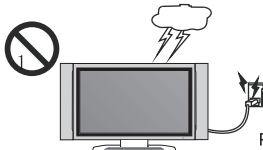
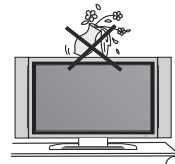

Pull out the power cord and antenna cable during electrical storms so the LED TV is not damaged by electrical surges. Keep all people away from the antenna cable during electrical storms.

The Front/Back diagram Of Set

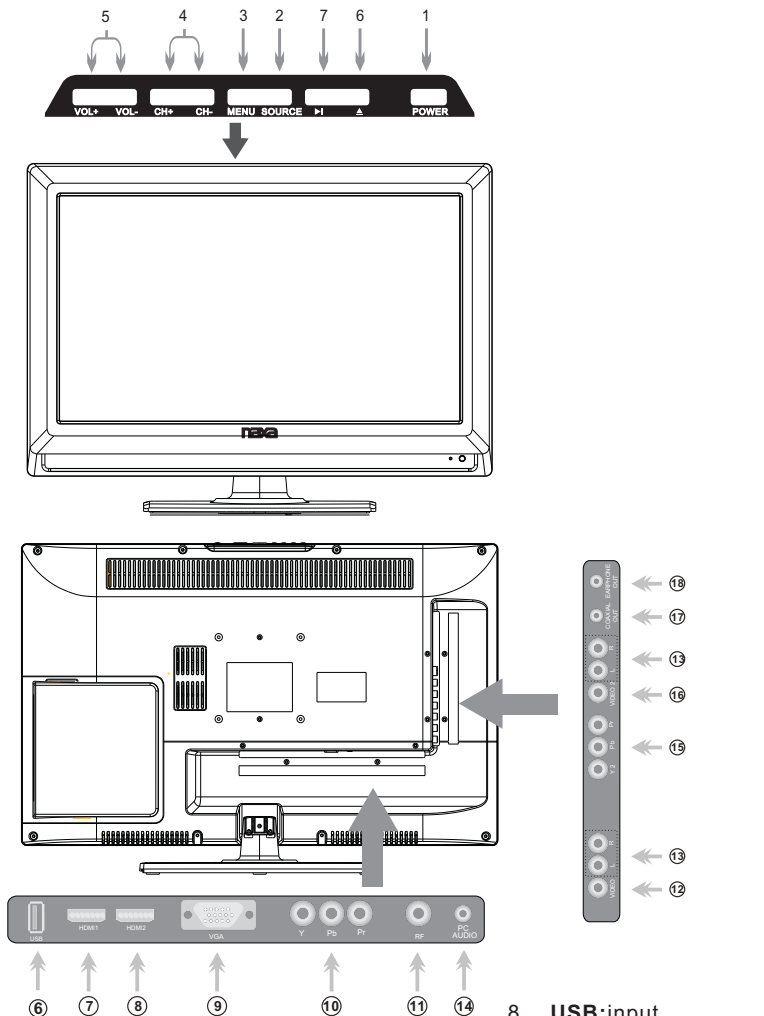

1. **POWER:** Turn on/off TV
2. **SOURCE:** Source select
3. **MENU:** Into or exit from menu
(Use CH+/- button to select,
VOL+/- button to adjust)
4. **CH+/-:** Select channel
5. **VOL+/-:** Adjust Volume
6. Press ▲ button on the side panel or on the remote controller.
7. After placed a disc in the disc tray, press >|| button to play the disc, and press >|| button twice to pause.

8. **USB:** input
9. **HDMI 1:** input
10. **HDMI 2:** input
11. **VGA(PC):** input
12. **Y Pb Pr:** input
13. **RF:** input
14. **VIDEO:** input
15. **VIDEO :** audio input
16. **PC AUDIO:** input
17. **Y Pb Pr(2):** input
18. **VIDEO(2):** input
19. **COAXIAL:** output
20. **EARPHONE:** output

Accessories

Please make sure the following items are included with your LED TV. If any items are missing, contact your dealer.



Remote Control &
Batteries (AAAx 2)

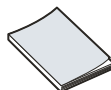

Owner's
Instructions



Car charger cable



Adapter

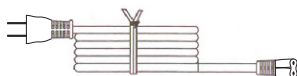

Power Cord

Remote Controller

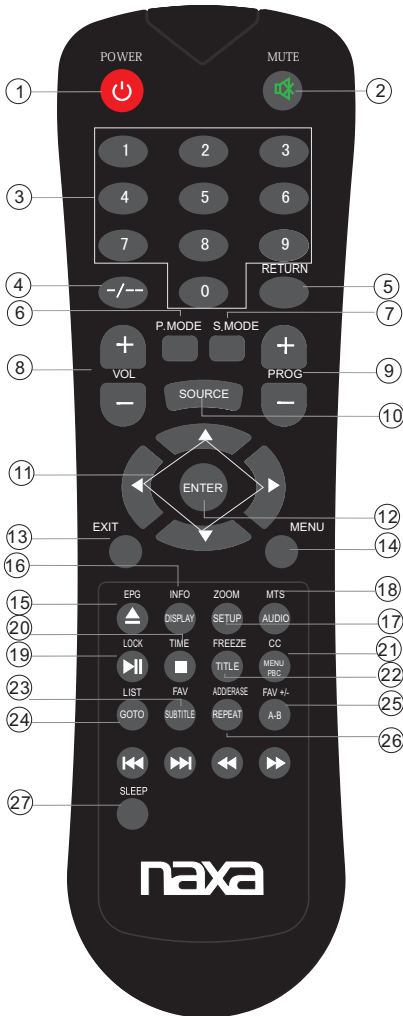

1. **POWER**: Switch an LCD TV when at standby mode or vice versa.
2. **MUTE**: Press to mute the sound. Press again or press VOL+ to unmute.
3. **Number key(0-9)**: Press 0-9 to select a TV channel directly when you are watching TV. The channel change after 2 seconds.
4. **-/--**: Press this button to enter a program number for multiple program channel such as 2-1, etc.
5. **RETURN**: Return to the previous channel viewed
6. **P.MODE**: Press repeatedly to cycle through the available video picture modes.
7. **S.MODE**: Press to cycle through the different sound settings.
8. **VOL +/-**: Press to increase/decrease the sound level.
9. **PROG +/-**: Press to scan through channels. To scan
10. **SOURCE**: Press to change input source.
11. **ARROW BUTTONS**(▲/▼/◀/▶): Use to move cursor up/down/left/right.
12. **ENTER**: Validation key.
13. **EXIT**: Press to exit all menu.
14. **MENU**: TV system setup.
15. **EPG**: Press to display the EPG menu.
16. **INFO**: Displays the channel information
17. **ZOOM**: Press to change the screen scale.
18. **MTS**: Press to select the audio channels.
19. **LOCK**: Press to display the parental menu.
20. **Time**: Press to display Time menu.
21. **CC**: press to display the closed caption
22. **FREEZE**: Press to freeze the screen.
23. **FAV**: Selects favorite channels.
24. **LIST**: Press to display the TV program list.
25. **FAV +/-**: press this button +/- the favorite program list.
26. **ADD**: Add this program to the favorite channels list .
ERASE: Delete this program from the favorite channels list .
27. **SLEEP**: Sets the sleep timer press the repeatedly to select sleep time among off, 30, 60, 90, 120.

General Description

Overview of remote control

DVD Mode :

When in DVD mode, use the arrows in the bottom section of the remote to operate the menus etc.

EJECT BUTTON(▲)

Press the EJECT button when the power is on the disc will eject. Put the disc in the slot slightly, with the data side facing towards you. Press EJECT button again the disc is pulled in automatically, and the unit starts playing automatically (Without auto play function for JPEG discs).

MENU PBC BUTTON

Press menu button and the screen will display

preference. (This button is valid to DVD disc possessing multilayer Menu). PBC button lets you play Video CDs, interactively. If PBC is on, you can use the number buttons to select tracks in the menu. If PBC is off, you can select the tracks directly.

AUDIO BUTTON

When play DVD, by pressing this button, you can change the audio language from the one selected at the initial settings to a different language, available.

REPEAT BUTTON(REP)

Press the REPEAT button one time, it repeats the chapter. Press it again and it repeats all chapters of the disc. Press REPEAT button one more time and the repeat function cancels.

A-B REPEAT BUTTON(REPA-B)

Press the A-B button once to set point A. Press the A-B button a second time to set point B. After setting the program repeat playing from A to B. Pressing the A-B button a third time will cancel the repeat.

TITLE BUTTON

Press TITLE button, there will have an screen indication

Press the direction or numeric buttons to select

your favourite title. Will play from the first chapter of the selected title.(for DVD disc only)

ENTER: Validation key. (bottom section of ENTER button for DVD function only)

ARROW BUTTONS (◀/▶/▲/▼): Use to move cursor up/down/left/right. (direction buttons of bottom section for DVD function only)

SUBTITLE: This function may enable you to select multi subtitle languages (as many as 32 kinds only for the discs with multi subtitles encoded). Press the SUBTITLE button to get desired display.

DISPLAY: Press display button to show the the information of the DVD player.

GO TO BUTTON

Press this button to go to desired position. The player provides 3 search mode.



On the remote control, the bottom section ARROW BUTTONS (◀/▶/▲/▼): Up and down buttons of the OSD menu, to change the OSD menu items; Left and right buttons of the OSD menu, to select the OSD menu items. (only for DVD function)

When the above items are shown on LED screen, you can input numbers to locate desired sector.

The number you input is invalid if it is beyond the track s capacity.

General Description

PLAY AND PAUSE BUTTON(▶/⏸)

Press this button to start playback. Press this button again to pause playback.

STOP BUTTON(■)

Press button once to stop. Press button to resume from where you stopped.

Press button Twice to stop. Press button to start from beginning. In order to protect the disc, press button then press EJECT button to take the disc out. When the disc is ejected, hold the disc edge to prevent scratches.

When not using the DVD function (in standby mode or using others modes for a long time), please take out the disc to protect the DVD loader and the disc.

PREV/NEXT BUTTON(◀◀▶▶)

When playing a DVD disc, press PREV to play the previous chapter. when playing a SVCD, VCD, CD disc, press PREV to play the previous track.

When playing a DVD disc, press NEXT to play, the next chapter. when playing a SVCD, CD disc, press NEXT to PLAY the next track.

FR/FF BUTTON(◀◀▶▶)

To Use Fast Forward or Fast Reverse:

1. When playing a DVD, press FF button to fast forward through the disc. Press FR button to fast reverse through the disc.
2. Press PLAY button to resume normal playback.

SETUP BUTTON

Press this button to get the setup menu . you can select the setting as you like .

Systems Connections

Note: Please make sure the inputs or output are good connected before connecting power.

1. AV INPUT

Video / Audio input, use the **SOURCE** button to select **AV** or **AV 2** on the remote control .

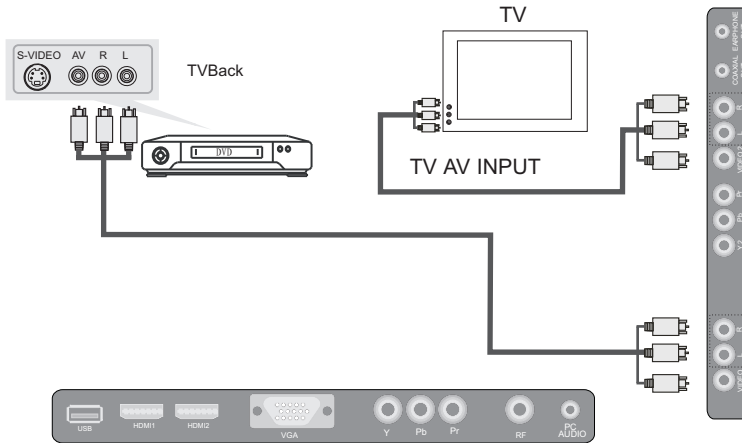

2. PC INPUT

Use the **SOURCE** button on the remote controller to select **PC** .

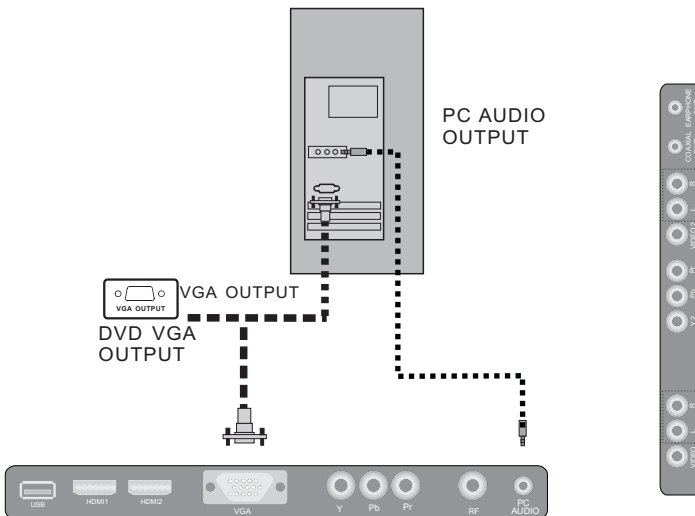

Systems Connection

3. HDMI INPUT

Use the **SOURCE** button on the remote controller to select **HDMI1** or **HDMI2**

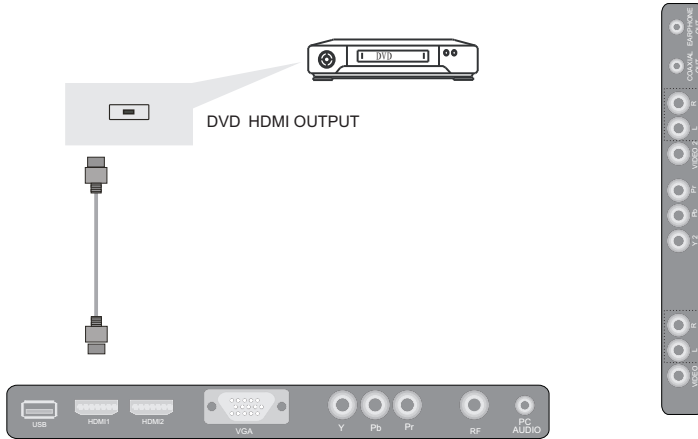

4. Y Pb Pr Input

Use the **SOURCE** button on the remote controller to select **Y Pb Pr**.

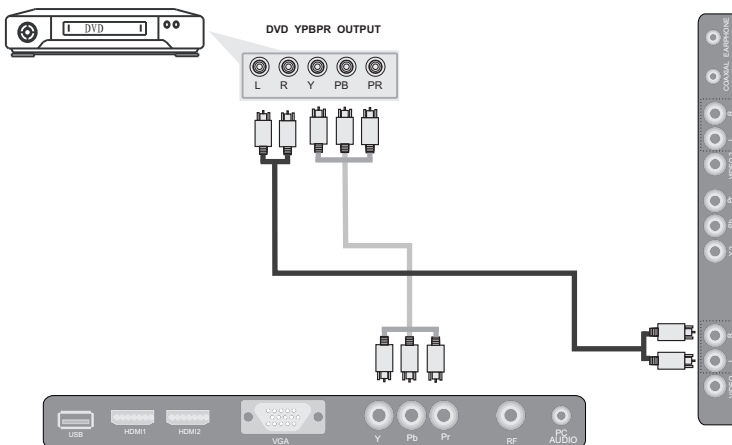

Systems Connection

5. USB INPUT

Use the **SOURCE** button on the remote controller to select USB .

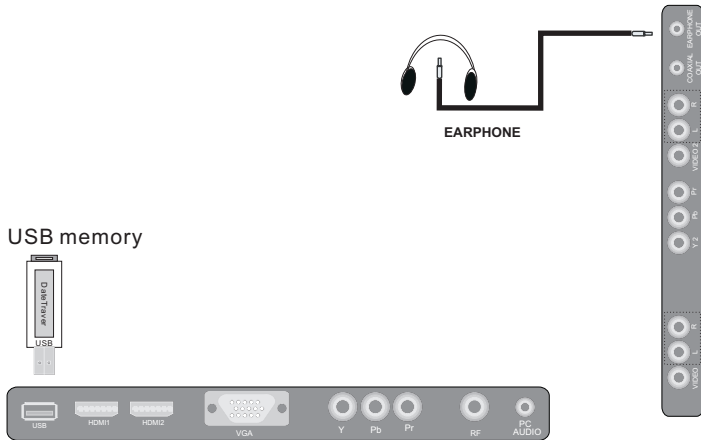

OSD Menu Operations

1. Auto Channel Search

Changing Channels Directly

You can use CH+ button to increase channel number and CH- to decrease channel number. When no OSD (On Screen Display) is used, the up/down arrows can also work as CH+/CH- buttons.

Selecting Input Source

Source Select
TV
AV 1
AV 2
YPbPr 1
YPbPr 2
DVD
HDMI 1
HDMI 2
VGA
Media

Press SOURCE button on remote control to display Source Select list. Use up/down arrows to highlight the source you need and press ENTER to confirm.

OSD Menu Operations

1. PICTURE

The OSD (On Screen Display) menu enables you to approach to the TV functions. To use OSD menu system, press MENU button on remote control, then use up/down arrow to highlight an option from PICTURE, SOUND, CHANNEL, PARENTAL, SETUP or OTHERS and press ENTER button. Press the up and down arrow to move to a different option within each menu. If necessary, press ENTER or right arrow to display the choices of the option you've highlighted. If available, use the text at the bottom of each screen for help. To return to the previous menu, press the MENU button.

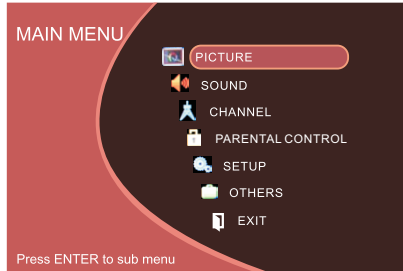

To exit the OSD menu:

- Press the EXIT button. The menu will clear from the screen.
- Press the MENU button repeatedly until the menus disappear.

Picture Menu

The Picture Menu contains menus and controls to configure the way the picture appears. The Picture Menu options apply to the video for the main TV and VIDEO INPUT selections. All picture options can be applied to each input.

Press MENU on the remote. Select Picture from the Main menu. Press the ENTER button to proceed to PICTURE menu.

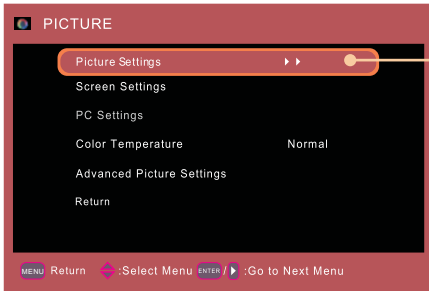

Use up/down to choose the function you need, press ENTER or right arrow to adjust or enter a sub-menu. This sub-menu image and explanation are shown below.

Picture Settings

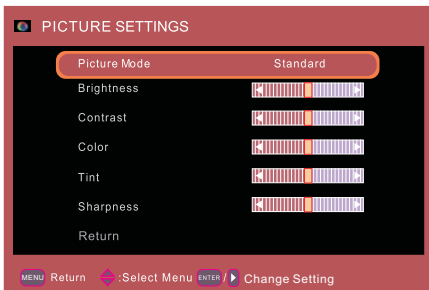

Picture Settings: Choose the preset visual mode of your TV: Standard, Movie, User, Dynamic. Only in User mode you can adjust Brightness, Contrast, Color, Tint and Sharpness. Brightness: Adjust the brightness of picture. Color: Adjust the richness of color. Tint: Adjust the balance between red and green level (only available in NTSC signal). Sharpness: Adjust the sharpness level of picture.

OSD Menu Operations

Screen Settings

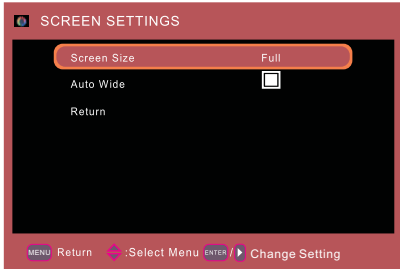

Screen Size: Select a screen aspect ratio. (Available ratio: Full, Normal, Waterglass and Cinema.) Please choose the ratio that applies to your video signal format

Auto Wide: Make the screen size compliant with signal format automatically.

If you turn on this function, the Screen Size setting will be ignored. Please choose the ratio that applies to your video signal format best.

PC Settings (only available in PC mode)

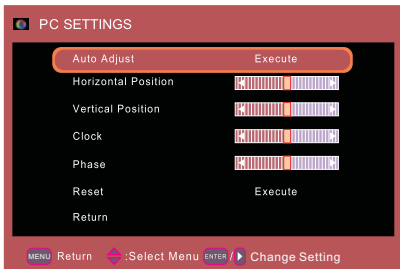

Auto Adjust: Adjust the PC picture display automatically.

Horizontal Position: Adjust the horizontal position of picture.

Phase: Adjust the phase of picture.

Reset: Reset all the PC picture settings to factory default.

Vertical Position: Adjust the vertical position of picture.

Clock: Adjust the clock of picture.

Color Temperature

This option allows you to select one of three automatic color adjustments: Cool for a bluer palette of picture colors; Normal or Warm for a redder palette of color.

Advanced Picture Settings (not available in PC mode)

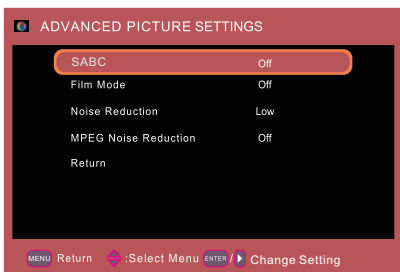

SABC: Set Dynamic Contrast as Off/low/Medium/High.

Film Mode: Set film mode on/off.

Noise Reduction: Set noise reduction as Off/low/Medium/High.

MPEG Noise Reduction: Set MPEG noise reduction as Off/low/Medium or High.

Note: Noise reduction helps to reduce the picture "static" or any type of interference. This feature is especially useful for providing a clearer picture in weak analog signal conditions. The MPEG Noise Reduction specifically works on video signal with MPEG coding.

OSD Menu Operations

2. Sound Menu

The Sound Menu lets you adjust audio output. To access the Sound Menu, press MENU on the remote, and then select SOUND from the Main Menu. Press ENTER button to proceed to SOUND menu.

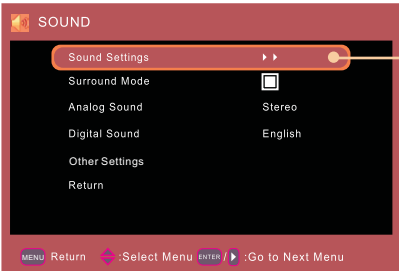

Use up/down to choose the function you need, press ENTER or right arrow to adjust or enter a sub-menu. The sub-menu image and explanation are shown below.

Sound Settings

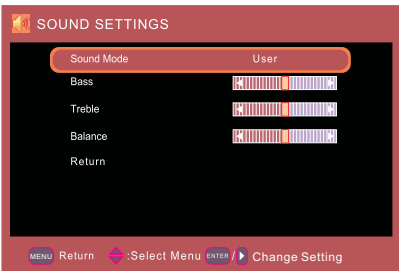

Sound Mode: Choose the preset sound mode of your TV: Standard, Soft, User, Dynamic. Only in User mode you can adjust Bass and Treble.
Bass: Adjust the bass component of TV sound.
Treble: Adjust the treble component of TV sound.
Balance: Adjust the balance between the left and right channel.

Surround Mode

Creates a 3D sound surround from standard stereo material, with deep and rich enhancement.

Analog Sound

Select analog TV audio sound type: Stereo, Mono or SAP (only available in TV mode).

Digital Sound

Select digital TV audio language type: English, French or Spanish (only available for DTV channel).

Other Settings

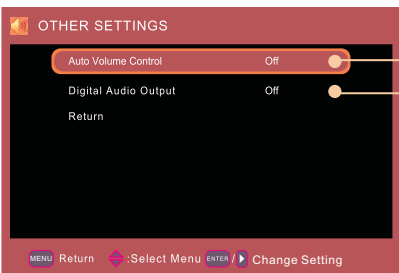

Set Auto Volume Control on/off.
Set the audio output type as Off, PCM or Dolby Digital. Please set this option according to your power amplifier.

OSD Menu Operations

3. Channel Menu

The Channel Menu enables you to search, view and edit channels. It is available in TV mode only.

Press MENU and choose CHANNEL from the Main menu. Press the ENTER button to proceed to CHANNEL menu.

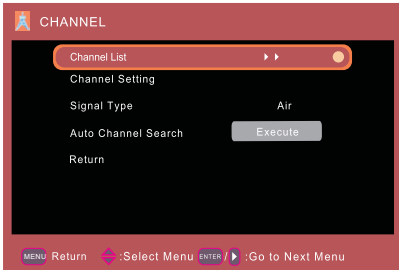

Use up/down to choose the function you need, press ENTER or right arrow to adjust or enter a sub-menu. The sub-menu image and explanation are shown below.

Channel List

Display a channel list. It shows the current channels.

Channel Settings

Go to channel setting sub-menu (as shown below).

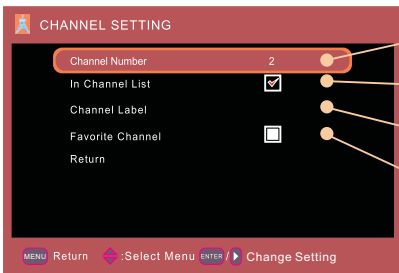

Press left/right arrow to switch the channel you want to edit.
Set if the current channel is contained in channel list.
Enter a channel label to rename the current channel.
Set if the current channel is the favorite channel.

Signal Type

Select your TV signal type: Air or Cable.

Auto Channel Search

Execute an auto channel search.

OSD Menu Operations

4. Parental Menu

The Setup Menu enables you to lock program with special content, panel key board and input source.

Press MENU and choose PARENTAL from the Main menu. Press the ENTER button to proceed to PARENTAL menu.

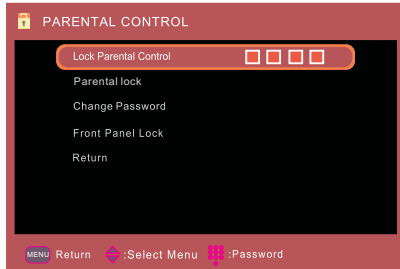

Lock Parental Control

- When the Parental Control Menu is accessed from the Main Menu, you need to enter password to unlock the menu function. Please enter your four-digit password with numeric keys 0~9.

Note: The original password is "0000".

- After unlocking, the items in parental control menu can be used. Use arrow up/down to highlight the function you need and press ENTER or right arrow to use V-chip, Change Password, Front Panel Lock and Source Lock, Clear Channel List sub-menu.

Parental Lock

The following graphic details where items locate within the Parental Lock menu.

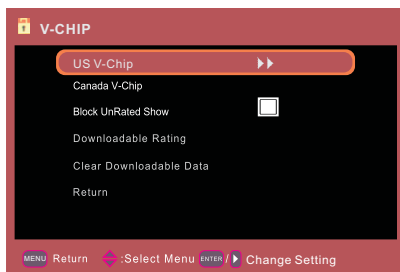

US V-Chip

Press ENTER or right arrow to enter US V-Chip ratings menu, which contains two sub-menus: Movie Rating and TV rating. See next page for more details.

OSD Menu Operations

Movie Rating

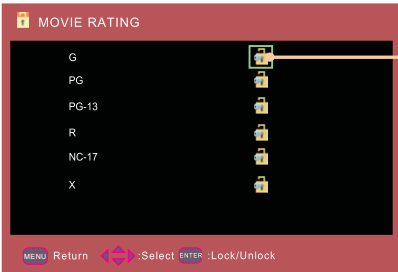

Use arrow keys to select the rating level you want to block, press ENTER to lock/unlock the rating level. If you have blocked a lower level rating, the higher ratings will be blocked too.

For example, when PG-13 is blocked, R, NC-17 and X will be blocked at the same time.

TV Rating

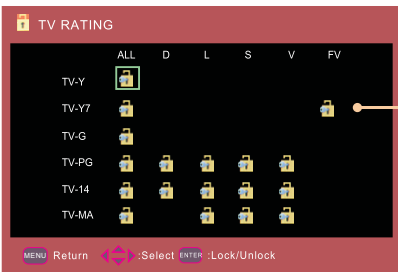

Similar with Movie Rating.

After adjusting, press MENU to return or press EXIT to exit the menu..

TV Rating Overview

	Age-Based Ratings		Content Themes
TV-MA	Mature Audience Only	D	Sexually Explicit Dialogue
TV-14	Parents Strongly Cautioned	L	Adult Language
TV-P	Parents Guidance Suggested	S	Sexual Situations
TV-G	General Audience	V	Violence
TV-Y7	Directed to Children 7 Years and Older	FV	Fantasy Violence
TV-Y	All Children		

OSD Menu Operations

Canada V-Chip

Press ENTER or right arrow to enter US V-Chip ratings menu, which contains two sub-menus: English Rating and French Rating.

English Rating

Press ENTER or right arrow to enter English rating menu.

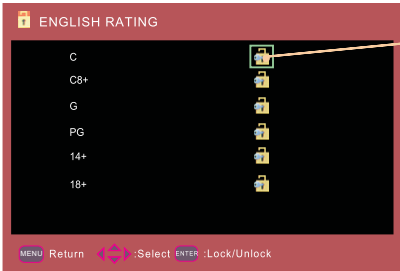

Use arrow keys to select the rating level you want to block, press ENTER to lock/unlock the rating level. If you have blocked a lower level rating, the higher ratings will be blocked too.

For example, when PG is blocked, 14+ and 18+ will be blocked at the same time.

French Rating

Press ENTER or right arrow to enter French rating menu.

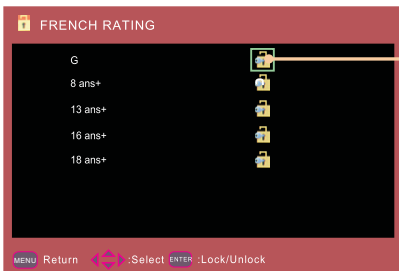

Similar with English Rating.

Note: These ratings are available only if the broadcaster is sending rating information.
Similar with English Rating.

Block Unrated Show

Block all the unrated program.

Downloadable Rating, Clear Downloadable Data

Activate or downloadable rating data, if available.

Change Password

Change the password of parental menu.

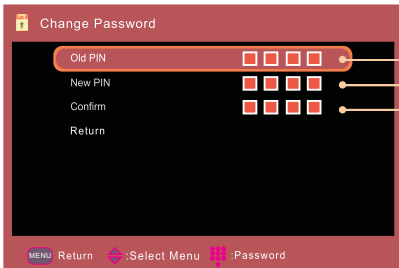

Input the old password.

Input the new password.

Input the new password again to confirm.

OSD Menu Operations

Front Panel Lock

Select this option to block or unblock the TV's side panel buttons so that they can't be used.

5. Setup

The Setup Menu lets you config the TV with your preferences.

Select SETUP from the Main Menu. Press ENTER button to proceed to SETUP menu.

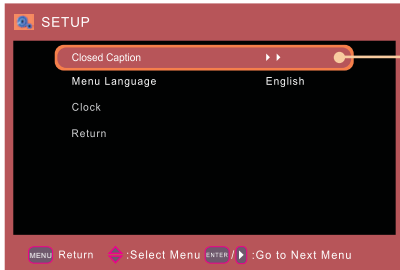

Use up/down to choose the function you need, press ENTER or right arrow to adjust or enter a sub-menu. The sub-menu image and explanation are shown below.

Menu Language: English, Spanish, Portuguese.

Closed Caption

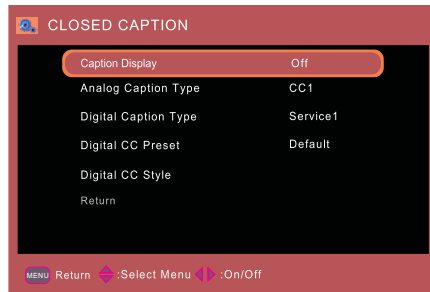

Caption Display

Press left/right arrow to select closed caption display on or off.

Analog Caption Type

Press left/right arrow to select analog closed caption type: CC1, CC2, CC3, CC4, TEXT1, TEXT2, TEXT3, TEXT4.

Digital Caption Type

Press left/right arrow to select digital closed caption type: Service1, Service2, Service3, Service4, Service5, Service6.

Digital CC Preset

Press left/right arrow to select digital closed caption preset: Default, Custom. Only in custom mode you can adjust the digital closed caption style.

Digital CC Style

Press left/right arrow to go to digital closed caption style sub-menu (see next page).

OSD Menu Operations

Digital CC Style

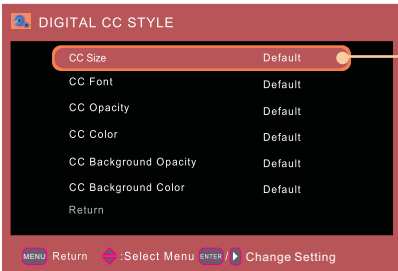

Select the item you want to adjust in Digital CC Style menu with up/down arrows.

Clock

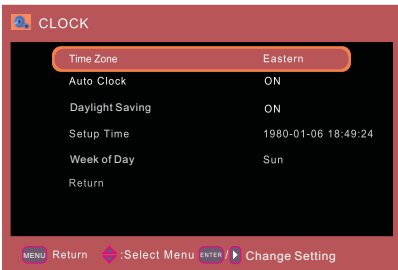

Time Zone

Select your time zone: Eastern, Central, Mountain, Pacific, Alaska, Hawaii, Atlantic.

Auto Clock

Select auto clock on/off. Auto clock helps you synchronize your TV time to standard time (from DTV signal).

Daylight Saving

Set daylight Saving time ON/OFF.

Setup Time

Set your TV time manually (needs to turn off auto clock).

Week of Day

Display what day it is (can't be adjust, display only).

OSD Menu Operations

6. Others Menu

The Others Menu lets you config the TV with your preferences in other features. Choose OTHERS from the Main Menu. Press ENTER button to proceed to SETUP menu.



Use up/down to choose the function you need, press ENTER or right arrow to adjust or enter a sub-menu. The sub-menu image and explanation are shown below.

ATV Blue Back

Press ENTER button to select Blue Background on or off. If the Blue Background is turned on, the TV will display a blue background when there is no signal input.

No Signal Power Off

Press ENTER button to select "No Signal Power Off" on or off. If it is turned on, the TV will shut off after 5-minute no signal time. We suggest you turn on this function when Blue Back is turned on. Because it may hurt the LCD panel if the blue screen lasts too long.

Note: In PC mode, the monitor standby and power off settings depend on the No Signal Off time.

No Operation Power Off

Press ENTER button to select "No Operation Power Off" on or off. If it is turned on, the TV will shut off after a 3-hoursno operation time.

All Reset

Press ENTER button to execute reset to TV system. All the settings will be reset to factory default.

NOTE:

- The LED TV also can be used as computer monitor. Electromagnetic interference in the environment May appear slight diagonal line interference. But this does not affect the quality of TV.
- In order to obtain better quality, with a recommendation of the use of high quality high noise isolation filter Quality HDMI / VGA cables.

RESOLUTION

VGA

Resolution	640x480	800x600	1024x768	1360x768	1920x1080
Vertical frequency (Hz)	60	60	60	60	60

HD (Y Pb Pr)

Resolution	480i	480p	720p	1080i/p
Vertical frequency (Hz)	60	60	50/60	50/60

HDMI

Resolution	480i	480p	720p	1080i/p
Vertical frequency (Hz)	60	60	50/60	50/60

MTS (Optional)

Press the MTS button:

Usually set to **stereo** to provide the best reproduction, but if reception deteriorates or if the service is not Available, it will switch to Mono.

DVD OPERATION

Basic Operation

1. Turn On theTV and then press“SOURCE” button of the remote controller, the TV willswitch into DVD mode.
2. Place a disc horizontally into the disc slot,it will then be automatically loadedinto the mechanism.
NOTE:Another disc can not be loaded if there isalready one in mechanism.
- b. No disc in mechanism, it will be initialized when the power turns on (automatically loads in about7 seconds).
- c. When it ejects,the disc will be automatically reload after about 10seconds later if not removed.
- d. Compatible with both 12CM disc.
 - a) Menu Play(compatible with DVD VCD2.0 discs)
 - I. Stop
 - 1)W hen you press theStop button for the first time,the player to pre-stop mode.
 - 2) In pre-stopmode ,the player emembers where you have stopped,when you start playing the discagain,the DVD player will pick up where you stopped.
 - b) Title Play (compatible with DVD discs only).
 - I. During DVD playback, press theTitle button to display the DVDtitle contents.
 - c) Program Play (compatible with DVD, VCD,CD, JPEG discs) The program Playback option allows you to enter the order in which you want chapters or tracks to be played,a maximum of16.

DVD OPERATION

Press **SETUP** button on the remote the display then setup menu.

Press **◀ / ▶** button to select General Setup Page

Press **▼ / ▲** button to select the desired item

Press **▶** button to enter sub menu

Press **◀** button to enter upper menu

General Setup

TV Shape

Please select screen format (aspect ratio) according to the type of TV that you use.

4:3 Panscan : The central section of anamorphic widescreen images is visible on a 4:3 TV, but the left and right edges are truncated.

4:3 Letterbox : Anamorphic widescreen images are visible in their entirety on a 4:3 TV, but there are black bands at the top and bottom of the screen.

Wide : Select this option if you are connecting the player to a wide screen TV. However, you will not be able to view DVDs recorded in 4:3 as complete 16:9 images even if you select this option.

Captions

Play the enclosed captions on some DVD titles, Optional settings: ON/OFF.

OSD Language

Please select the language, Press **ENTER** button to save operation

Last Memory

Please select your desired mode
ON: Press open button when you watch a DVD, it can play go on to the broken segment if you close the player.
OFF: No memory function;

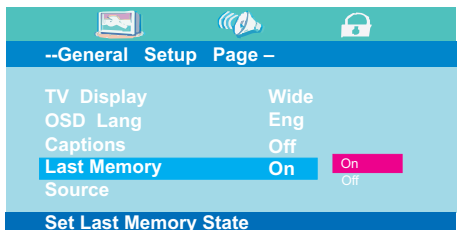
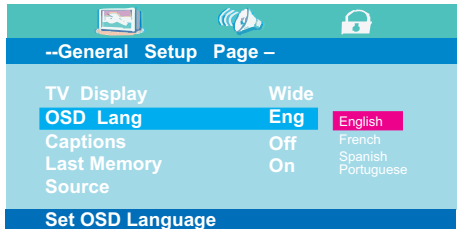
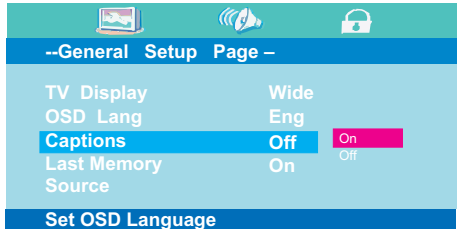
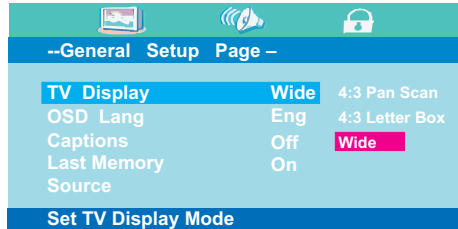
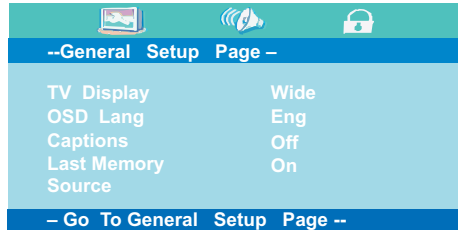

DVD OPERATION

Source

Please select this item when you want to play the media files in SD card.

order to code it as two-channel audio. This

Spdif Output

Please Select the Spdif output.
Press ENTER button to save operation.

Preference Set

TV Type

Please select the TV system ,
Press ENTER button to save operation

Audio

Please select the preferred language for DVD audio.

- 1) The selected language is assigned high priority and can therefore be adopted automatically when the player begins playing a disc.
- 2) Languages vary between discs, depending on the DVD. You can also select alternative languages by pressing the AUDIO button on the remote

Subtitle

Selects the preferred language for subtitles recorded on Discs.

- 1) The selected subtitle language is assigned high priority and can therefore be adopted automatically when the player begins playing a disc.
- 2) Subtitles vary between discs, depending on the Discs. You can also select alternative subtitle language by pressing the SUBTITLE button on the remote.

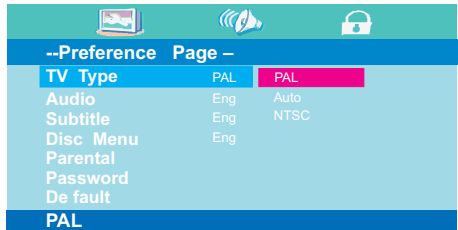
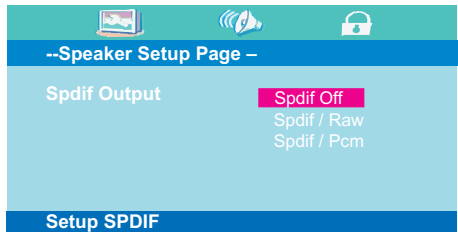
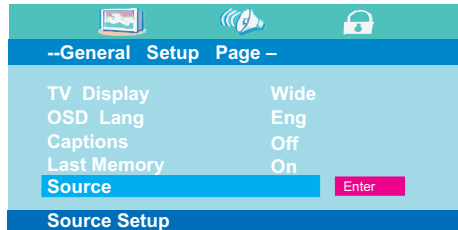

DVD OPERATION

Disc Menu:

Select the preferred language for the disc menu recorded on the Discs. This choice varies between Discs.



Parental

It is possible to restrict playback of certain Discs to a certain level of user, based on their age, for example. Certain scenes can be blocked or replaced with different scenes. The "Parental Control" function lets you set the access control level. This function is password-protected.

Note: If you play discs that do not support the Parental Control function, the DVD player cannot restrict access to the disc.



Password

Change the password to your desired. The default password is 8888.

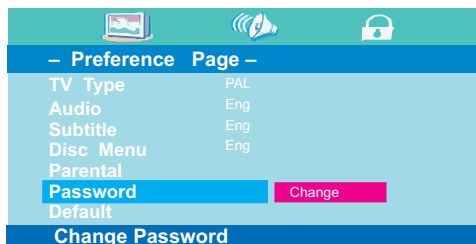

Default

Restore the DVD player's system to factory default settings



USB/SD OPERATION

Card Reader and USB player

The card reader can read SD/MMC/MS 3 kinds of cards and USB storage

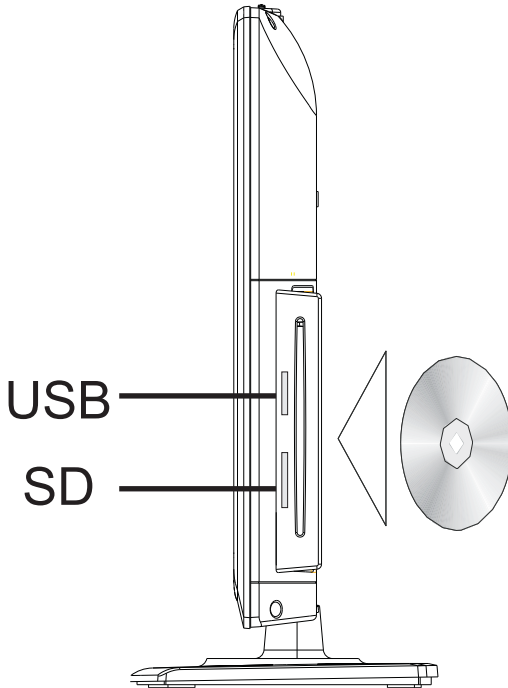

Media Support List:

Media Type	Format	Remark
Video	*.MPG,*.DAT	MPEG-1/2
	*.VOB	MPEG-2 MP@ML
	*.AVI	Xvid
Audio	MP3	
	WMA	
Photo	JPEG	Resolution size limit: no limitation File size limit: no limitation

HELP

No Power	<ul style="list-style-type: none"> ● Check the AC cord of TV is plug in or not. If still no power, please Pull out the plug and replug in after 60 seconds. And open the TV again
Signal reception not properly	<ul style="list-style-type: none"> ● To cause double image or phantom if there has high building or high mountain round TV. You can adjust image effect by manually operation: consult instruction of vernier regulation or change the direction of external antenna. ● If you use the indoor antenna. under certain circumstance, receive will be more difficult. So you can change the direction of the antenna to adjust the image effect. If can't change image receiving effect either, you have to use external antenna.
No picture	<ul style="list-style-type: none"> ● Check the antenna at the back of TV is connected properly or not. ● Try to select other channels and check whether the TV problem itself or not
Video is ok, but without audio	<ul style="list-style-type: none"> ● Increase the volume. ● Check the TV is in mute mode or not, and please press the mute button to make sound resume.
Audio is ok, but color error or no picture.	<ul style="list-style-type: none"> ● Increase contrast and brightness.
snow statics picture and noise	<ul style="list-style-type: none"> ● Check the antenna at the back of TV is connected or not.
Level broken line	<ul style="list-style-type: none"> ● Maybe has electrical appliance interfere, such as hair drier, vacuum cleaner and so on, please turn off these kinds of electrical appliance.
Dual-Image or "simulacrum" The TV no response with the Remote.	<ul style="list-style-type: none"> ● Perhaps the location for the antenna is not good. Use the tall beamed antenna can be improved quality of the display image. ● Operate the remote direct to the remote sensor on the TV. If still no response for the TV, please check if the plastic bag on the remote take or not. And check if the location for the battery is correct. Change the new battery. ● The TV will shift to the STAND BY if no response from the remote in the few minutes.
NO Video In. (PC Mode)	<ul style="list-style-type: none"> ● Please check if the display cable connect to the VGA correct. ● Please check if there has the bend on the display cable.
Vertical twinkling (PC Mode)	<ul style="list-style-type: none"> ● Enter the main menu, Use the clock regulator for the Video display noise to eliminate the vertical line.
horizontal ripping (PC Mode)	<ul style="list-style-type: none"> ● Adjust the Audio sound horizontal in the main menu to clear the horizontal ripping line.
The screen is too bright or too dark (PC Mode)	<ul style="list-style-type: none"> ● Adjust the contrast ratio or brightness in the main menu.
PC Function no response	<ul style="list-style-type: none"> ● Check the computer setting in the state of compatible display resolution
Ripping line in RCA connecting	<ul style="list-style-type: none"> ● Please use good quality connecting cable.
Problem still exist	<ul style="list-style-type: none"> ● Unplug the power cable and wait for 30 seconds, then connect. If there is some problem with our TV, do not repair it by yourself, please contact with the customer service center.

SPECIFICATIONS

MODEL	NTD-2252	
Display size	22"	
The maximum resolution	1920X1080	
Power consumption	35W	
Display screen type	Color active matrix LED display	
Image control	Fine digital control	
Adapter requirement	IN Put	AC100-240 50/60Hz
	IN Put	DC 12V = 4A
TV receive system	NTSC System, ATSC System	
Frequency range	Antenna: 2~69; Cable: 1~135 (Analog: 1-125, Digital: 1-135)	
Video IN	NTSC3.58	
Antenna input impedance	75 (Unbalance)	
Sound output (Max)	5W x 2	
Power supply for remote controller	DC 3V (Two AAA size batteries)	
Operation environment temperature	0C°-40C°	

Note:

Design and specification modification maybe made at any time without prior notice; all data and dimensions are approximations.

USER'S MANUAL